

EC 常规金属叶片轴流风机
EC Conventional Carbon Steel Blade Axial Fan

ErP2015
EXCEEDS THE NORM



Φ 630

转子材质 Rotor Material: 碳钢 Carbon steel
风叶材质 Blade Material: 碳钢 Carbon steel
防护等级 Ingress Protection: IP54
绝缘等级 Insulation Class: F
轴承类型 Bearing Type: 免维护滚珠轴承
Maintenance free ball bearing

性能曲线 Performance Curves

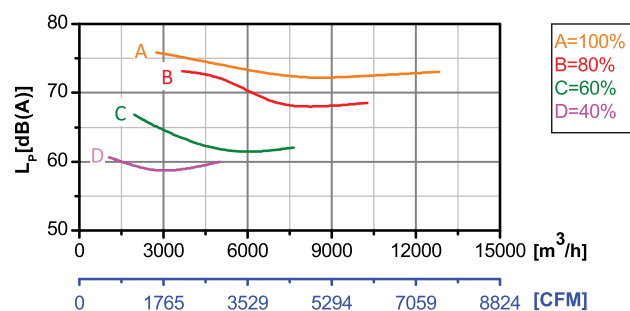
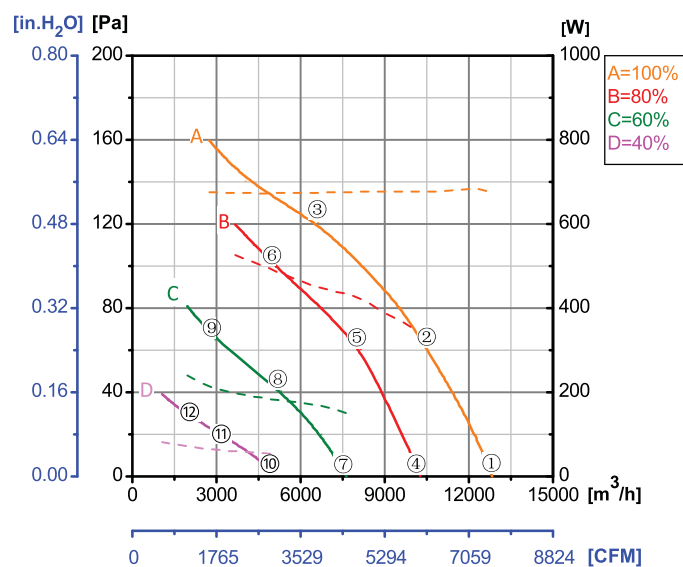

测试节点 Test Point	转速 Speed rpm	输入功率 Input Power W
1	1155	673
2	1101	677
3	1051	674
4	927	339
5	931	429
6	930	488
7	694	151
8	695	181
9	695	203
10	467	54
11	465	62
12	466	73

Erp2015 Data:
Efficiency η_{statA} = 37.1%
Efficiency grade N_{actual} = 44.5, N_{target} = 40
Test report No. : L-20210302-004-058

产品型号 Model No.	电压 Voltage	频率 Frequency	转速 Speed	输入功率 Input Power	电流 Current	运行温度 Working Temp.	认证 Approvals
	VAC	Hz	RPM	W	A	Min/Max (°C)	
EC137-A630-011	1~220/230	50/60	1160	650	4.20	-20/+60	CCC, CE

风机本体 Type A

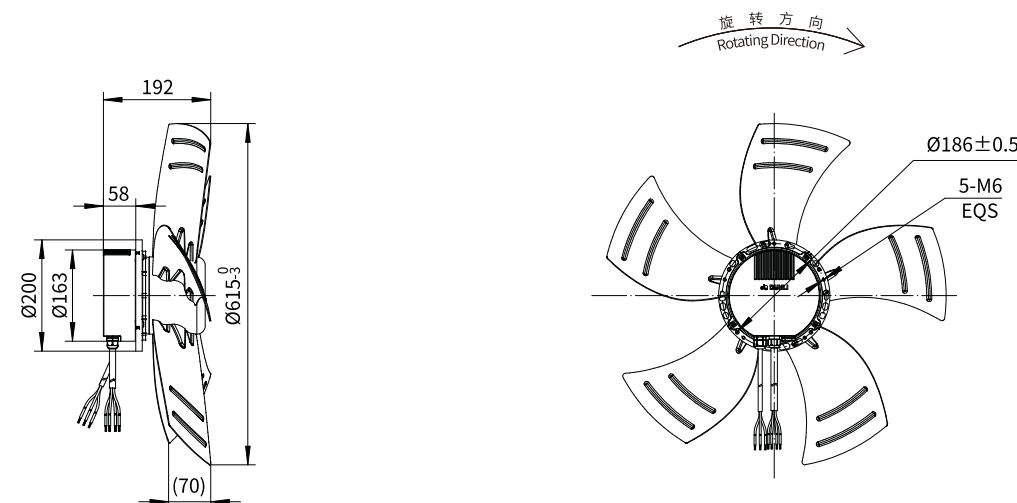

D 型网罩 Type D

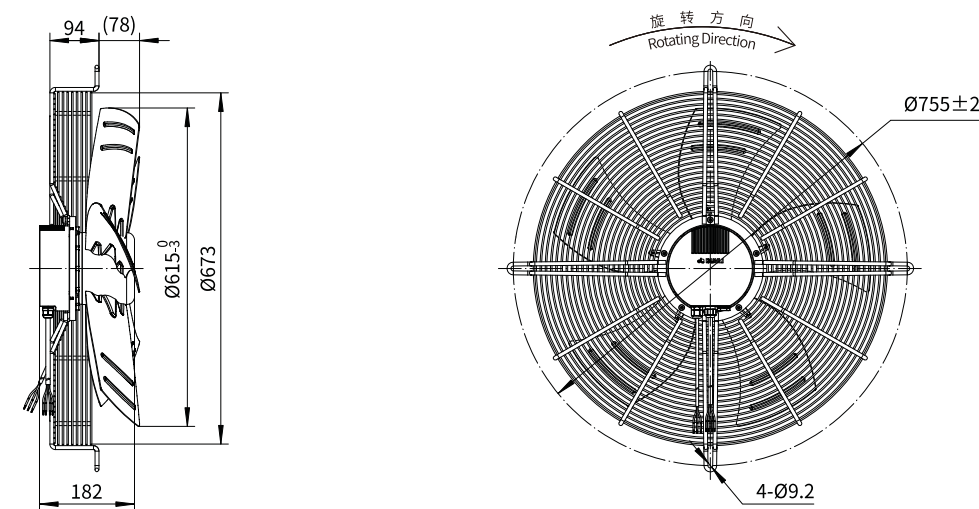

F 型面板 Type F

