

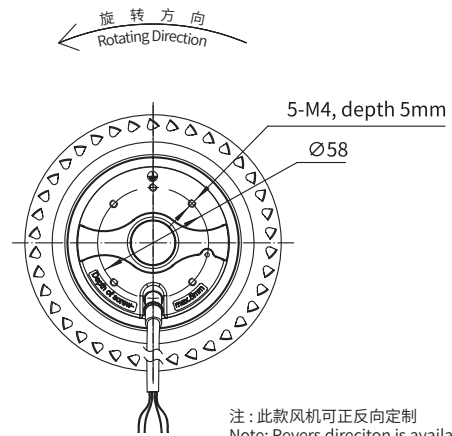

前倾离心风机
Forward Curved Centrifugal Fan

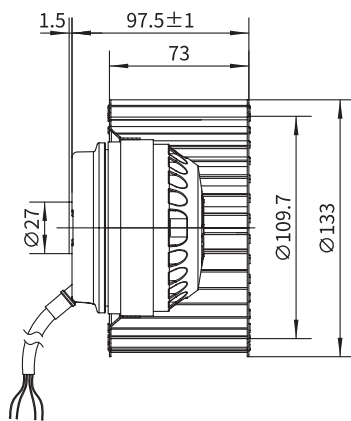

Φ 133

转子材质 Rotor Material: 铸铝 Aluminum Die-casting
 叶轮材质 Impeller Material: 镀锌板 Galvanized Steel Sheet
 防护等级 Ingress Protection: IP44
 绝缘等级 Insulation Class: F
 轴承类型 Bearing Type: 免维护滚珠球轴承
 Maintenance Free Ball Bearing

产品尺寸图 Dimensional Drawings

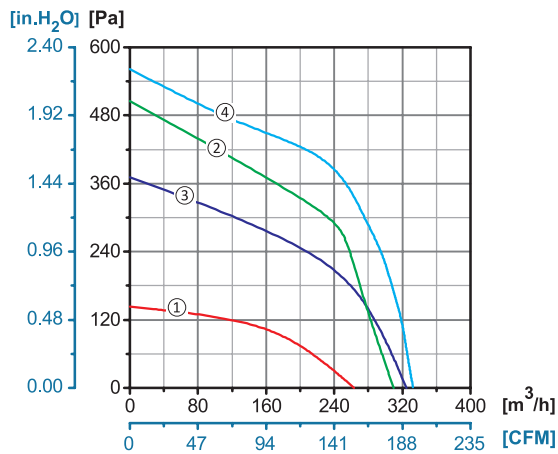

性能曲线 Performance Curves



产品型号 Model No.	电压 Voltage	频率 Frequency	电流 Current	功率 Power	转速 Speed	电容 Capacitor	风量 Air Flow (0 Pa)	噪音 Noise	曲线 Curve	运行温度 Working Temp.	认证 Approvals
	V	Hz	A	W	RPM	μF	[m³/h]/[CFM]	dB(A)	No.	Min/Max (°C)	
YWF.F2S-133-073AX2A	110/120	60	0.87	100	2750	10	340/195	66	④	-30/+60	
YWF.F4S-133-073AX2A	110/120	60	0.36	42	1700	6	260/153	58	①	-30/+60	
YWF.F2S-133-073AX20	220/230	50	0.35	75	2500	3	330/194	65	③	-30/+60	CCC, CE
	220/230	60	0.48	100	2600	3	310/182	63	②	-30/+60	CE

