

DC 复翼叶轮后倾离心风机
DC Backward Curved Centrifugal Fan with Aileron Impeller

ErP2015
EXCEEDS THE NORM

后倾离心风机 Motorized Backward Curved Impeller



Φ 250

转子材质 Rotor Material: 碳钢 Carbon steel
 叶轮材质 Impeller Material: 塑料 Plastic
 防护等级 Ingress Protection: IP42
 绝缘等级 Insulation Class: F
 轴承类型 Bearing Type: 免维护滚珠轴承
 Maintenance free ball bearing

性能曲线 Performance Curves

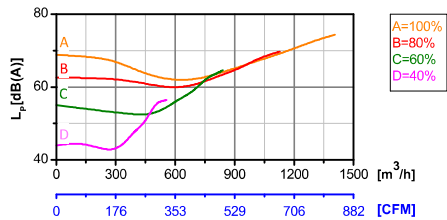
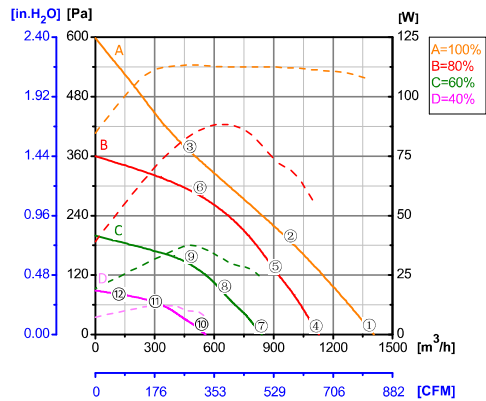

测试节点 Test Point	转速 Speed rpm	输入功率 Input Power W
1	4355	167
2	4210	170
3	4142	170
4	3488	81
5	3483	87
6	3486	90
7	2616	28
8	2616	31
9	2615	34
10	1745	8
11	1745	9
12	1745	10

Erp2015 Data:
 Efficiency $\eta_{statA} = \% < 125W$
 Efficiency grade $N_{actual} = *, N_{target} = 44$
 Test report No. : L-20210302-005-029

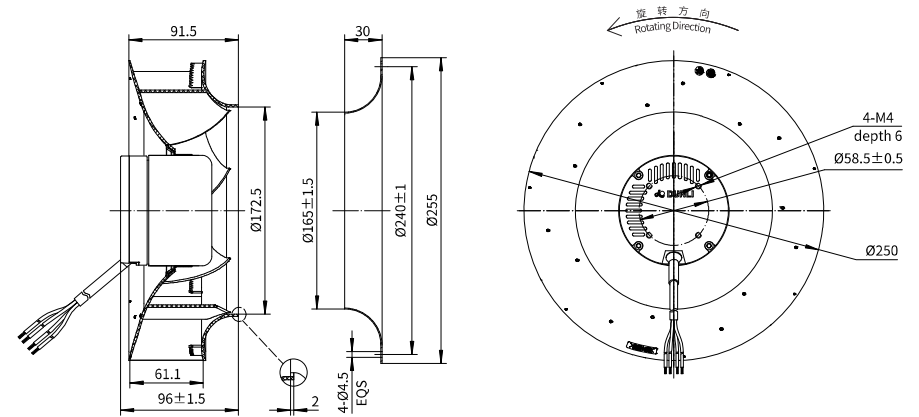

产品型号 Model No.	电压 Voltage	频率 Frequency	转速 Speed	输入功率 Input Power	电流 Current	运行温度 Working Temp.	认证 Approvals
	VDC	Hz	RPM	W	A	Min/Max (°C)	
DC92-B250-A01	24	/	2400	95	3.98	-20/+60	CE
DC92-B250-C01	48	/	2400	95	1.98	-20/+60	CCC, CE
DC92-B250-D01	310	/	2400	95	0.31	-20/+60	CCC, CE