

DC 高效塑料叶轮后倾离心风机
DC High-efficiency Backward Curved Centrifugal Fan

Erp2015
EXCEEDS THE NORM



Φ 133

转子材质 Rotor Material: 碳钢 Carbon steel
 叶轮材质 Impeller Material: 塑料 Plastic
 防护等级 Ingress Protection: IP42
 绝缘等级 Insulation Class: F
 轴承类型 Bearing Type: 免维护滚珠轴承
 Maintenance free ball bearing

性能曲线 Performance Curves

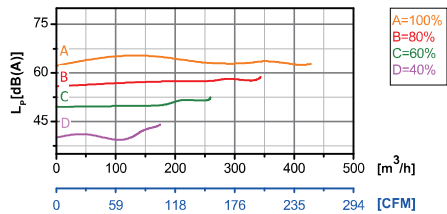
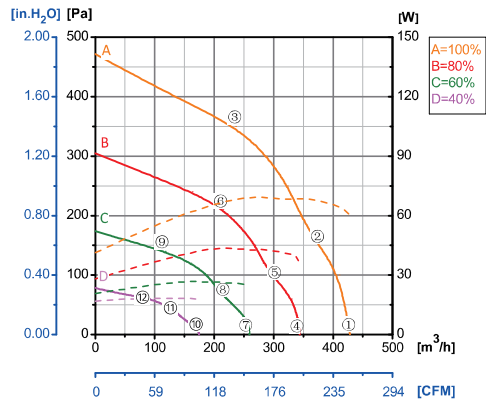

测试节点 Test Point	转速 Speed rpm	输入功率 Input Power W
1	4793	55
2	4793	67
3	4793	69
4	3830	36
5	3832	42
6	3832	43
7	2879	24
8	2878	27
9	2879	26
10	1921	18
11	1921	18
12	1921	18

Erp2015 Data:
 Efficiency $\eta_{statA} = \% < 125W$
 Efficiency grade $N_{actual} = , N_{target} = 62$
 Test report NO. : L-20210302-005-105

产品型号 Model No.	电压 Voltage	频率 Frequency	转速 Speed	输入功率 Input Power	电流 Current	运行温度 Working Temp.	认证 Approvals
	VDC	Hz	RPM	W	A	Min/Max (°C)	
DC72-B133-A10	24	/	4800	60	2.50	-20/+60	CE
DC72-B133-C10	48	/	4800	60	1.25	-20/+60	CCC,CE
DC72-B133-D10	310	/	4800	60	0.20	-20/+60	CCC,CE

后倾离心风机 Motorized Backward Curved Impeller (24V&48V)

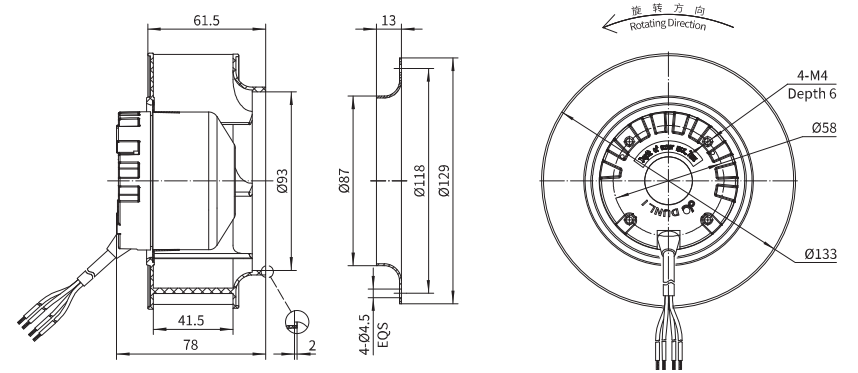

后倾离心风机 Motorized Backward Curved Impeller (310V)

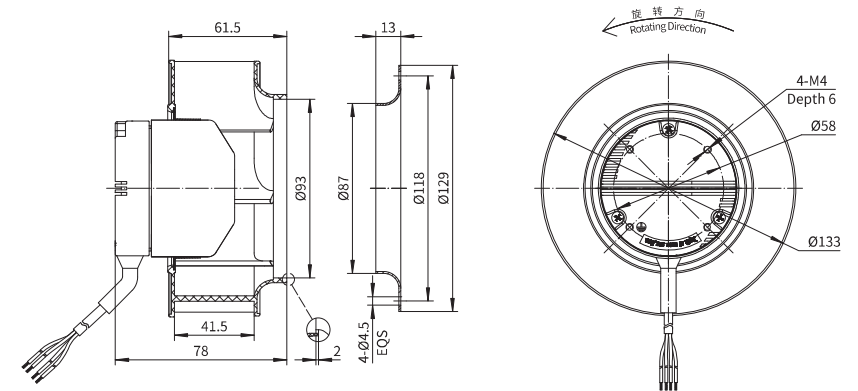

高效塑料叶轮后倾离心
High-efficiency B/C Centrifugal